

1	NUT HEX 3/4-10 ZP	4	125-0078-027
2	FOOT ADJUSTABLE LEVELER	4	125-0122-20-P
3	GUIDE RAIL/SINGLE TEE EXTRUSION	1	125-0168-024.91-EX
4	WEARSTRIP SINGLE TEE SLOT	1	125-0168-025.08-WS
5	WEARSTRIP SINGLE TEE SLOT	1	125-0168-058.72-WS
6	GUIDE RAIL/SINGLE TEE EXTRUSION	1	125-0168-059.06-EX
7	SINGLE TEE WEAR STRIP CLAMP ASSY	4	125-0168-CLMP-ASY
8	ASSY, ALUMINUM EXTRUSION CLAMP	8	1A0116A
9	PLATE BASE 3/4-10 TAP IN CENTER	4	1D0023A
10	CAP BLACK END	4	1D0026A
11	NUT ECONOMY T	26	1D0030A0002
12	T-NUT, ROLL-IN - M6 THREAD SERIES 15/40 SLOT	12	1D0030A0007
13	BRACKET 2 AXIS ADJUSTABLE GUIDE	6	1D0063A
14	BAR 1/2" ROUND	6	1D0088A0100
15	BAR 1/2" ROUND	2	1D0088A0150
16	BAR 1/2" ROUND	4	1D0088A0200
17	THUMBWHEEL M6	12	1D0091A
18	CLAMP 2 AXIS ADJ. GUIDE KNUCKLE, M6	6	1D0092A
19	EXTRUSION 51MM X 51MM	4	1D0136A0654
20	EXTRUSION 51MM X 51MM	2	1D0136A0655
21	MOUNT, LOW HEIGHT ANGLE CONVEYOR -	4	1D0428A-388957
22	T-NUT M8 DROP IN WITH BALL BEARING	8	1D0458A001
23	CB80 CONVEYOR 90 DEG BELT CURVE	1	CB080-W600-90-IR400-CWX-C-V
24	BRACKET, STAND - CB80	4	CB8-0001
25	SCREW HEX HEAD CAP M6 X 1 X 12 ZP	4	HHCS-M06X100X012-ZP
26	SCREW HEX HEAD CAP M8 X 1.25 X 16 ZP	8	HHCS-M08X125X016-ZP
27	SCREW PAN HEAD CAP ST M6 X 1 X 16mm ZP	16	PHCS-M06X100X016-ZP-ST
28	SEW SA37 GEARMOTOR 1/2HP 25:1	1	SA37-50T23-025A-DC2
29	SCREW SOCKET HEAD CAP M6 X 1 X 12 ZP	16	SHCS-M06X100X012-ZP
30	SCREW SOCKET HEAD CAP M6 X 1 X 14 ZP	8	SHCS-M06X100X014-ZP
31	SCREW SOCKET HEAD SET M6 X 1 X 25 ZP	2	SHSS-M06X100X025-ZP
32	SCREW SOCKET LOW HEAD M6 X 10 BX	18	SLHCS-M6X100X010-BX
33	WASHER FLAT M6 X 12 OD ZP	8	WSHF-M06X12X16-ZP
34	WASHER LOCK M6	8	WSHL-M06-ZP
ITEM	DESCRIPTION	QTY	PART NUMBER

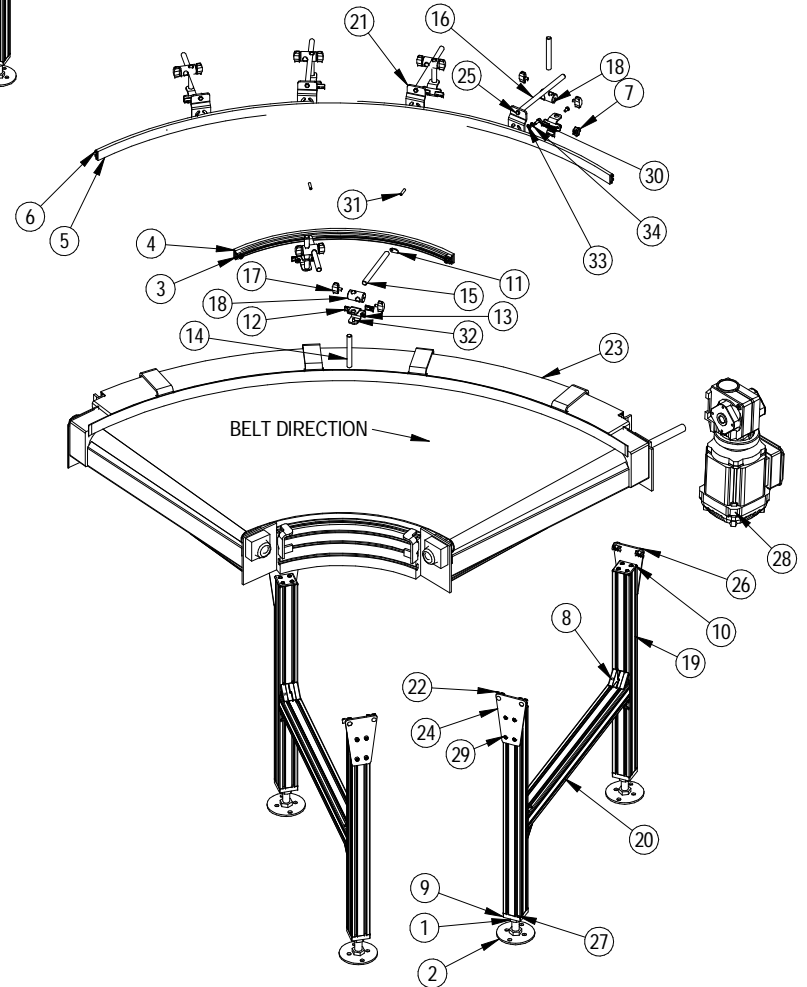

139440	11/22/24		PAK	ZLR	PAK	NEW
NOTICE	DATE	REV	DWN	CHK	APP	CHANGE

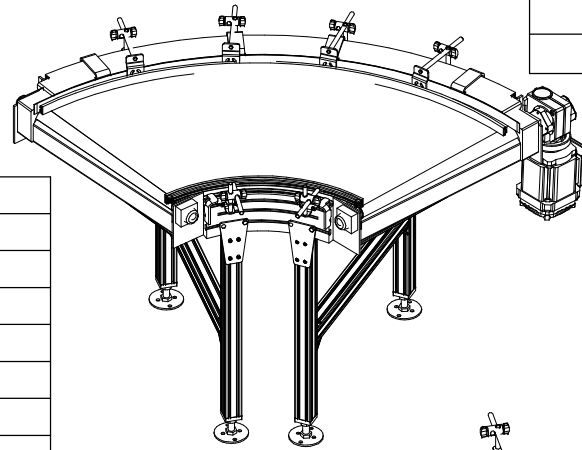
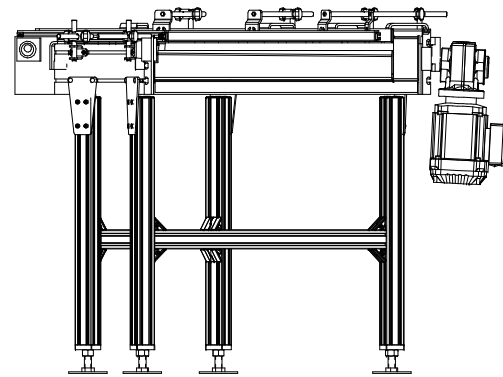
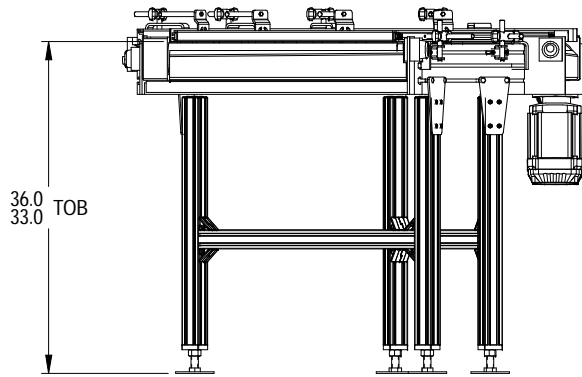
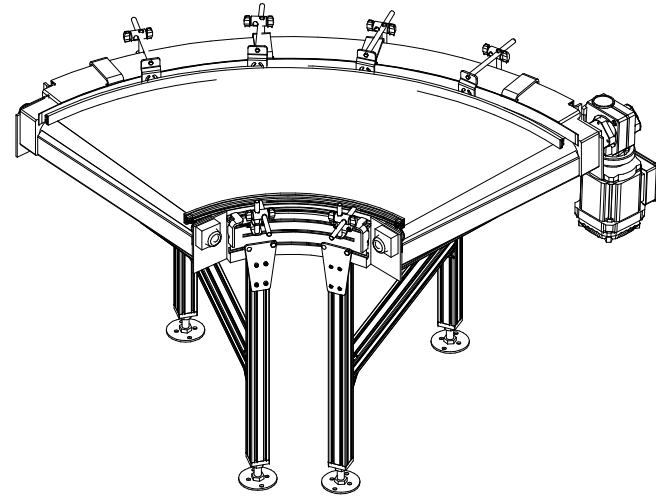
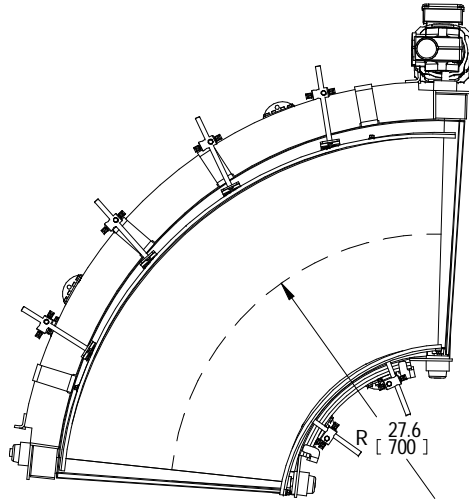

ITEM	DESCRIPTION	QTY	PART NUMBER
------	-------------	-----	-------------

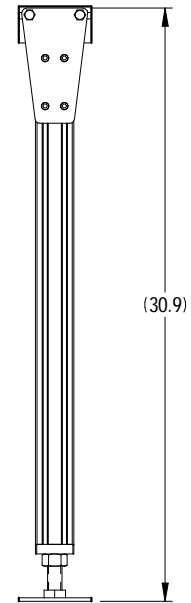
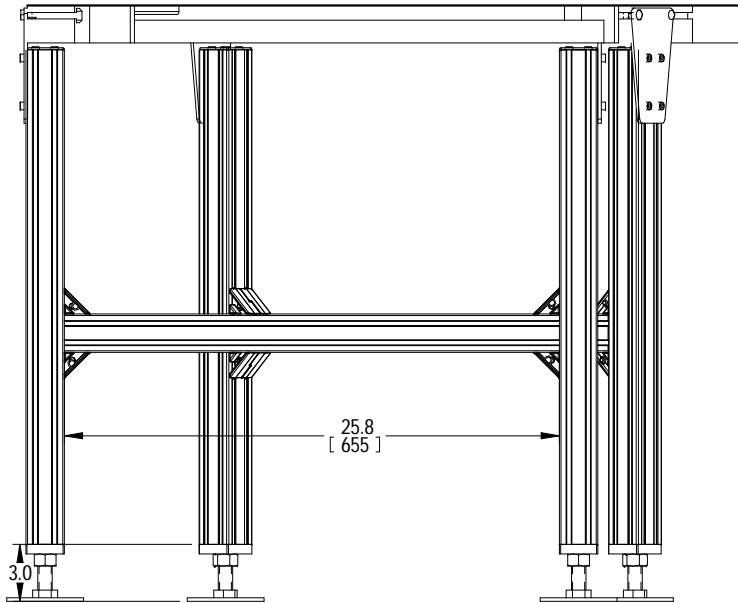

ITEM	DESCRIPTION	QTY	PART NUMBER
------	-------------	-----	-------------